

# SCULPFLOOD



Designer : Voxdale

## Versatile floodlights for large-scale accent and architectural lighting

The SCULPFLOOD LED floodlight range includes two power versions to provide the best solution to transform medium and large architectural structures including skyscrapers, monuments, façades, roundabouts, bridges and stadiums into landmarks.

Compact and stylish, the SCULPFLOOD range offers refined floodlights with a high-quality build, feel and finish. The two versions provide a high degree of flexibility with an on-site adjustable photometry and precise fine-tuning through brackets. These features help lighting designers deliver their desired result.

SCULPFLOOD is dedicated to creating striking lighting effects and enhance the value of architectural buildings at night. Through control systems, dynamic lighting scenarios can be achieved for a dramatic result.

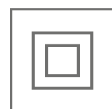

## Concept

SCULPFLOOD is composed of a die-cast aluminium body and a protector in tempered glass or polycarbonate.

This range of architectural floodlights is equipped with 32 or 96 high-power LEDs and available with symmetrical or elliptical light distributions. SCULPFLOOD is the beneficial alternative to traditional HID floodlights for powerful and soft-edge beams. The range ensures a heavily reduced energy consumption and longer lifespan.

SCULPFLOOD 60 and SCULPFLOOD 150 can be fitted with monochromatic (WW, NW, CW), tunable white and RGBCW LEDs to provide a wide range of colour temperatures and colour mix.

The easy plug-in external refractors enable precise on-site photometric settings. It also offers the flexibility to change the light distribution at any time to answer future lighting requests.

For more installation flexibility and to satisfy specific constraints (high ambient temperature for example), the driver and the power supply can be installed remotely.



Monochromatic, RGBW and tunable white LEDs are available.



Dynamic lighting scenarios can be controlled via the DMX-RDM protocol.

## TYPES OF APPLICATION

- ACCENT & ARCHITECTURAL
- BRIDGES

## KEY ADVANTAGES

- Precise on-site photometric distribution via external refractor
- Discreet 4 colour LED solution or all-white
- Internal surge protection to shield the electronics from external surges and spikes on the supply
- Inclination angle indicated on bracket
- Wide range of operating temperatures



SCULPFLOOD is installed using a graduated fixation bracket.



The range includes two sizes: SCULPFLOOD 60 and SCULPFLOOD 150.

## GENERAL INFORMATION

Driver included	Yes
CE mark	Yes
ROHS compliant	Yes
French law of December 27th 2018 - Compliant with application type(s)	a, b, c, d, e, f, g
Testing standard	LM 79-08 (all measurements in ISO17025 accredited laboratory)

## HOUSING AND FINISH

Housing	Aluminium
Optic	Polycarbonate
Protector	Tempered glass Polycarbonate
Housing finish	Polyester powder coating
Standard colour(s)	AKZO grey 900 sanded
Tightness level	IP 66
Impact resistance	IK 06, IK 08

· Any other RAL or AKZO colour upon request

· IK may be different according to the size/configurations. Please consult us.

## OPERATING CONDITIONS

Operating temperature range (Ta)	-20°C up to +50°C / -4°F up to 122°F
----------------------------------	--------------------------------------

· Depending on the luminaire configuration. For more details, please contact us.

## ELECTRICAL INFORMATION

Electrical class	Class I EU, Class II EU
Nominal voltage	220-240V – 50-60Hz
Surge protection options (kV)	10
Electromagnetic compatibility (EMC)	EN 55015 / EN 61547
Control protocol(s)	DALI, DMX-RDM
Control options	Custom dimming profile, Remote management
Associated control system(s)	Nicolaudie Pharos

## OPTICAL INFORMATION

LED colour temperature	RGB CW 3000K (Warm White 830) 4000K (Neutral White 840)
Colour rendering index (CRI)	>80 (Warm White 830) >80 (Neutral White 840)

## LIFETIME OF THE LEDS @ TQ 25°C

All configurations	100,000h - L79
--------------------	----------------

## DIMENSIONS AND MOUNTING

AxBxC (mm   inch)	SCULPFLOOD 60 - 147x270x271   5.8x10.6x10.7 SCULPFLOOD 150 - 94x393x551   3.7x15.5x21.7
Weight (kg   lbs)	SCULPFLOOD 60 - 8.5   18.7 SCULPFLOOD 150 - 18   39.6
Mounting possibilities	Bracket enabling adjustable inclination

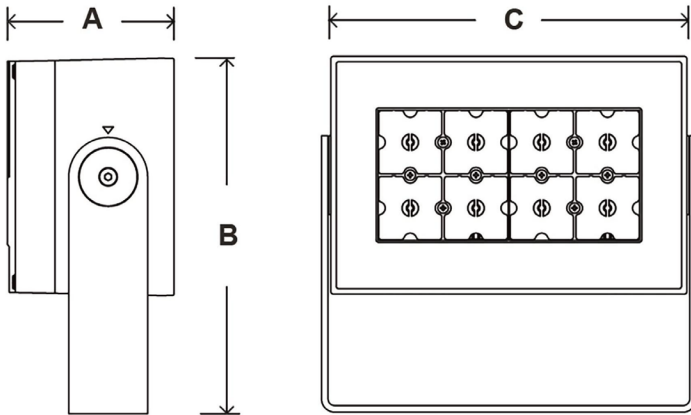

## SCULPFLOOD | U-shaped stirrup adjustable bracket

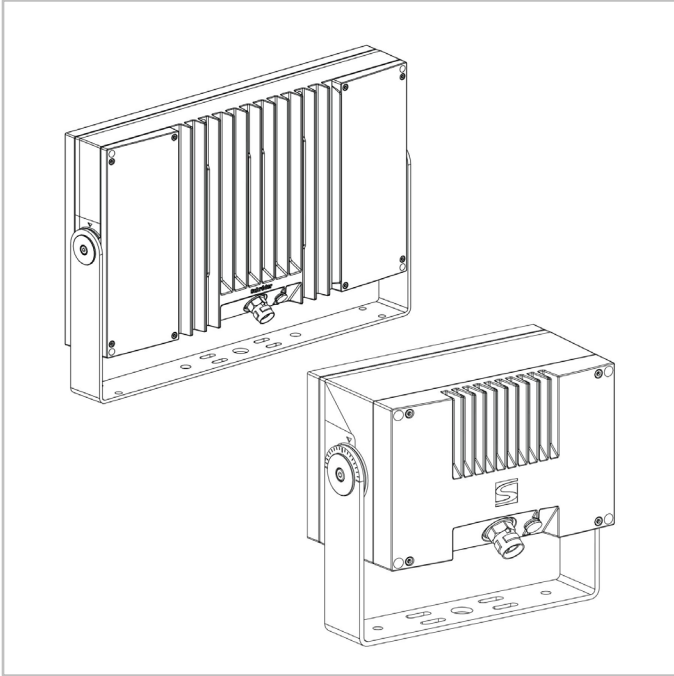



Luminaire	Number of LEDs	Current (mA)	Luminaire output flux (lm) Warm White 830		Luminaire output flux (lm) Neutral White 840		Luminaire output flux (lm) RGB CW		Power consumption (W)	Luminaire efficacy (lm/W)
			Min	Max	Min	Max	Min	Max		
SCULPFLOOD 60	32	350	-	-	-	-	1600	2500	41	61
	32	600	3600	5100	3900	5500	-	-	66	83
	32	650	3800	5300	4000	5700	-	-	70	81
SCULPFLOOD 150	96	350	-	-	-	-	5000	8100	120	68
	96	500	7300	14200	7700	15100	-	-	164	92
	96	650	8700	17000	9300	18100	-	-	212	85

Tolerance on LED flux is  $\pm 7\%$  and on total luminaire power  $\pm 5\%$

5124 RGB+CW (all ON 100%) Narrow Beam, No diffuser

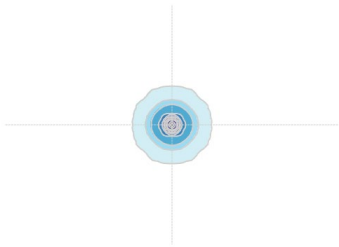
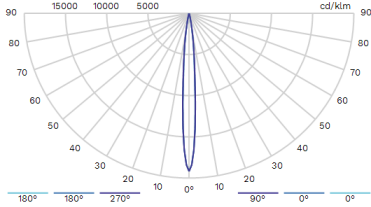

6275 - Circular Beam

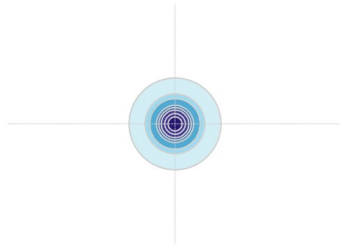
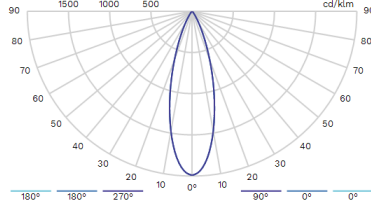

6276 - Circular Beam

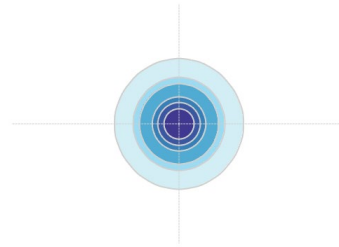
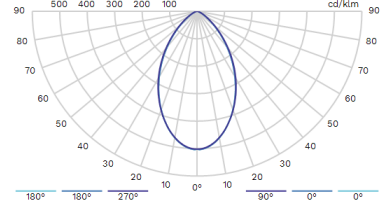

6277 RGB+CW (all ON 100%) Elliptical, Horizontal Beam

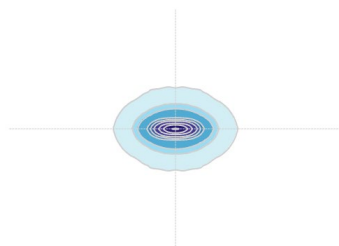
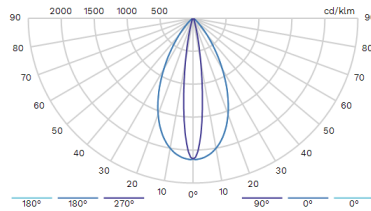

6278 - Elliptical, Horizontal Beam

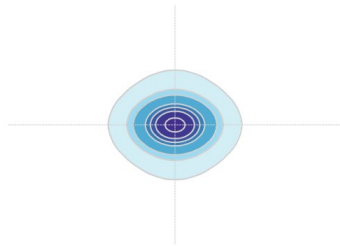
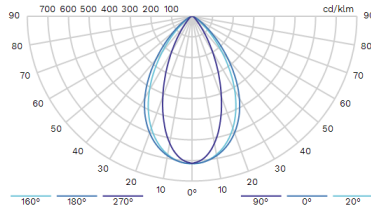

6297 - Elliptical, Horizontal Beam

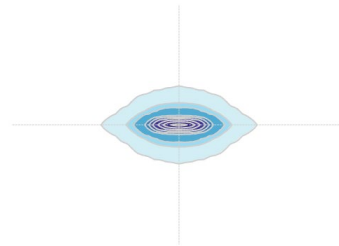
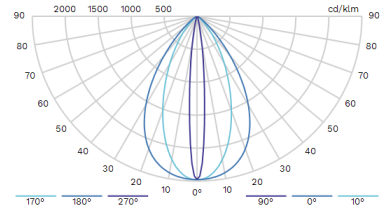

6298 - Circular Beam

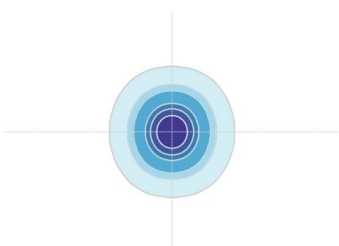
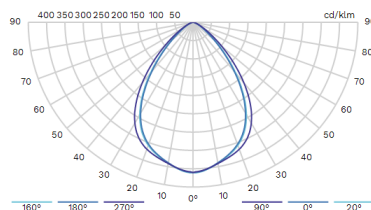

6316 - Circular Beam

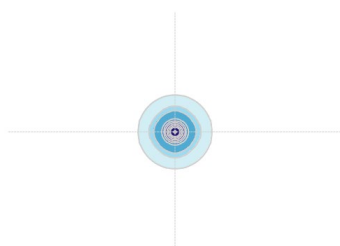
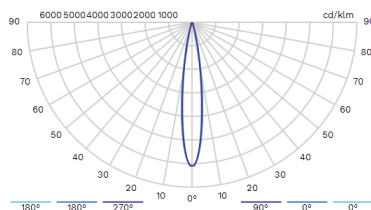

6318 - Elliptical, Vertical Beam

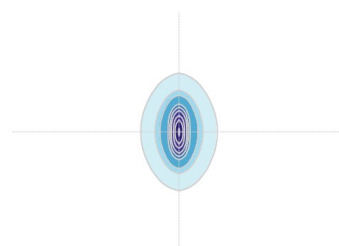
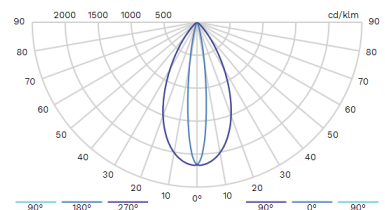

6322 - Elliptical, Vertical Beam

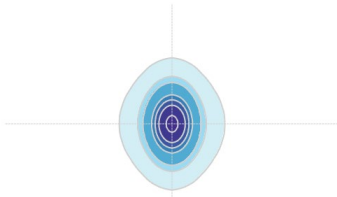
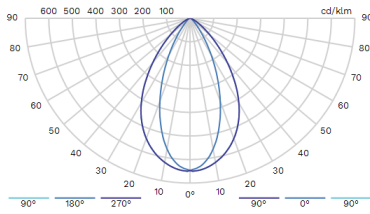

6323 - Elliptical, Vertical Beam

