

# AVENTO

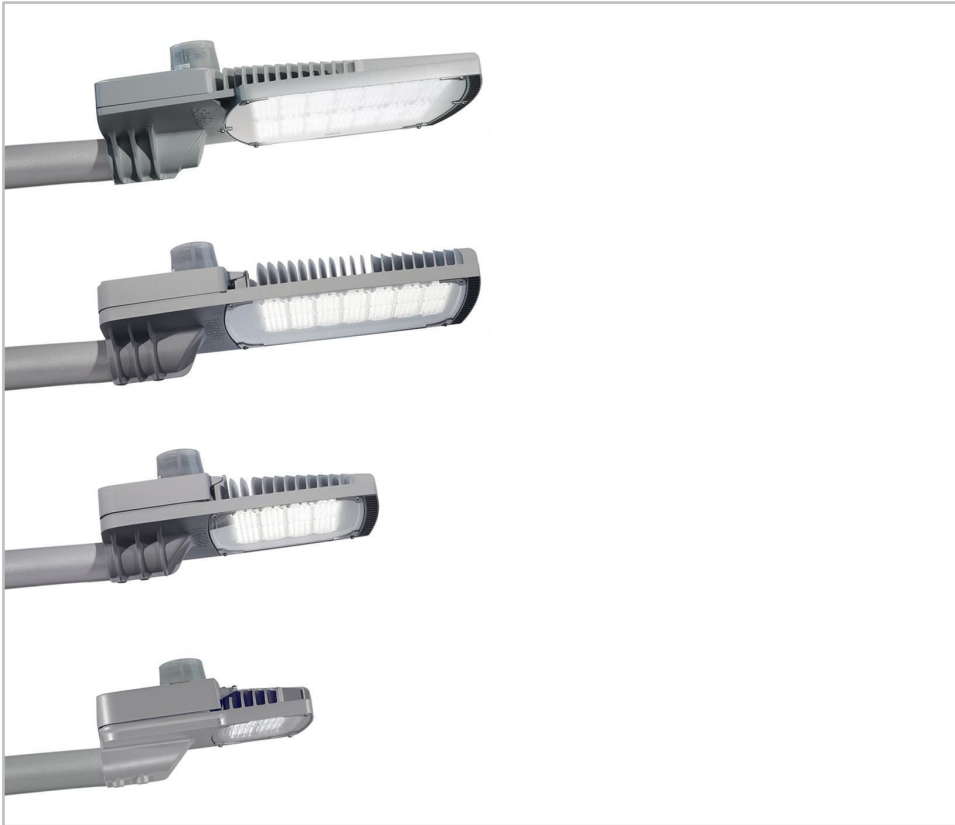

LENSO  
**FLEX™ 2**

LENSO  
**FLEX™ 4**

HI  
**FLEX™ 1&2**

HI  
**FLEX™ 2**

MID  
**FLEX™**

## The budget-friendly high efficacy solution

Compact yet powerful, light yet robust, affordable yet highly efficient, AVENTO provides the fastest return on investment for road and area lighting. AVENTO offers a superior lumen/watt ratio to deliver a high-performing, energy efficient, lighting solution at an affordable price for various landscapes including pedestrian areas, streets, roads, car parks and motorways.

AVENTO is available in four sizes to provide a consistent solution in terms of the right lumen package and light distribution for a broad range of environments. It ensures that the lighting meets the real needs of the place to be lit. AVENTO is the ideal tool to shorten the payback time of an LED lighting installation and to provide the best return on investment.

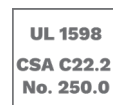
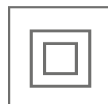

## Concept

The AVENTO range combines the energy efficiency of LED technology with the photometric performance of the MidFlex™, LensoFlex® and HiFlex™ concepts developed by Schröder. These photometric engines provide the highest efficiency. It offers scalable lumen packages with modular quantities of LEDs and various driving currents.

The AVENTO luminaires are composed of two parts in painted die-cast aluminium. An optional highly anti-corrosive aluminium (compliant with EN AC-44300) is available for seaside and harsh environments.

The luminaire is equipped with two silicone gaskets, one for the gear compartment and one for the optical unit, to ensure a high tightness level and maintain performance over time.

AVENTO is designed for side-entry mounting with a universal fixation for spigots from Ø42 to Ø60mm. To ease maintenance operations, AVENTO offers a tool-free access to the gear compartment.

As an option, AVENTO can be equipped with a standard NEMA 7-pin receptacle or a standard Zhaga socket, enabling easy entry to the digital era of lighting with advanced lighting features that plan, monitor and control outdoor lighting networks.



AVENTO provides tool-free access to the gear compartment.



AVENTO includes a universal Ø42-60mm fixation part for side entry-mounting.

## TYPES OF APPLICATION

- URBAN & RESIDENTIAL STREETS
- BIKE & PEDESTRIAN PATHS
- RAILWAY STATIONS & METROS
- CAR PARKS
- LARGE AREAS
- SQUARES & PEDESTRIAN AREAS
- ROADS & MOTORWAYS

## KEY ADVANTAGES

- Cost-effective and efficient lighting solution
- Superior efficacy
- Accelerated return on investment
- 4 sizes for flexibility and consistency when lighting P1 to P6 and M1 to M6 applications in accordance with CIE 115
- Easy and fast installation
- Wide temperature operating range
- Dark sky compliant: ULOR = 0%, no up-light
- Connected-ready for your future Smart city requirements
- LensoFlex®4 versatile solutions for high-end photometries maximising comfort and safety
- HiFlex™ photometric engine designed for optimised energy efficiency



To ensure an optimal thermal management in hot conditions, AVENTO incorporates large cooling fins.



AVENTO can be delivered with a shorting cap to add IoT features at any time in the future.

**LENSO FLEX™ 2** LensoFlex®2

LensoFlex®2 is based upon the addition principle of photometric distribution. Each LED is associated with a specific PMMA lens that generates the complete photometric distribution of the luminaire. The number of LEDs in combination with the driving current determines the intensity level of the light distribution.



**LENSO FLEX™ 4** LensoFlex®4

LensoFlex®4 maximises the heritage of the LensoFlex® concept with a very compact yet powerful photometric engine based upon the addition principle of photometric distribution. The number of LEDs in combination with the driving current determines the intensity level of the light distribution. With optimised light distributions and very high efficiency, this fourth generation enables the products to be downsized to meet application requirements with an optimised solution in terms of investment.

LensoFlex®4 optics can feature backlight control to prevent intrusive lighting, or a glare limiter for high visual comfort.

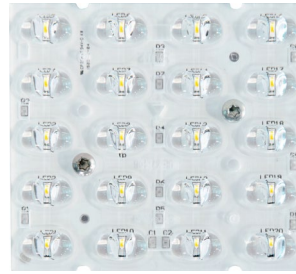

**MID FLEX™** MidFlex™

The MidFlex™ photometric engine is based on the same principle as LensoFlex®2: each LED is associated with a specific lens that generates the complete photometric distribution of the luminaire. MidFlex™ takes advantage of the maturity of mid-power LEDs for professional applications. The MidFlex™ photometric engines are based on the combination of several modules of 48 mid-power LEDs tightly positioned to maximise the LED density. This concept provides high lumen packages with a limited product footprint. The MidFlex™ photometric engines offers excellent efficiency for a sustainable performance.



**HI FLEX™** HiFlex™

The HiFlex™ platform is expertly designed to optimise energy efficiency. Its photometric engines feature high-power LEDs that deliver exceptional performance while consuming minimal energy, resulting in unmatched efficacy (lm/W).

Ideal for projects that require a streamlined approach to maximising lighting efficacy and achieving swift ROI, HiFlex™ is available in two versions: HiFlex™1, boasting 24 LEDs and HiFlex™2, equipped with 36 LEDs. Both variants are designed with the priorities of compactness, cost-effectiveness and high performance in mind.



### Constant Light Output (CLO)

This system compensates for the depreciation of luminous flux to avoid excess lighting at the beginning of the installation's service life. Luminous depreciation over time must be taken into account to ensure a predefined lighting level during the luminaire's useful life.

Without a CLO feature, this simply means increasing the initial power upon installation in order to make up for luminous depreciation. By precisely controlling the luminous flux, the energy needed to reach the required level can be maintained throughout the luminaire's life.

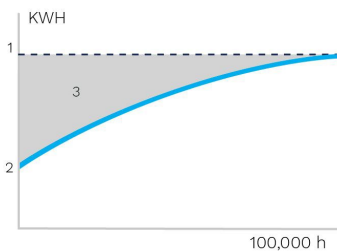

1. Standard lighting level | 2. LED lighting consumption with CLO | 3. Energy savings



### Custom dimming profile

Intelligent luminaire drivers can be programmed with complex dimming profiles. Up to five combinations of time intervals and light levels are possible. This feature does not require any extra wiring.

The period between switching on and switching off is used to activate the preset dimming profile. The customised dimming system generates maximum energy savings while respecting the required lighting levels and uniformity throughout the night.

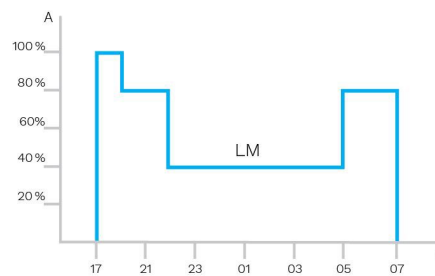

A. Dimming level | B. Time



### Daylight sensor / photocell

Photocell or daylight sensors switch the luminaire on as soon natural light falls to a certain level. It can be programmed to switch on during a storm, on a cloudy day (in critical areas) or only at nightfall so as to provide safety and comfort in public spaces.

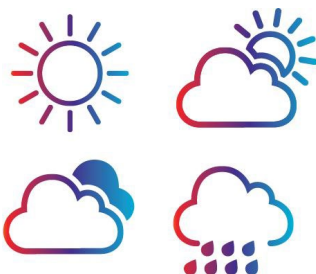

Schröder EXEDRA is the most advanced lighting management system on the market for controlling, monitoring and analysing streetlights in a user-friendly way.



## Standardisation for interoperable ecosystems

Schröder plays a key role in driving standardisation with alliances and partners such as uCIFI, TALQ or Zhaga. Our joint commitment is to provide solutions designed for vertical and horizontal IoT integration. From the body (hardware) to the language (data model) and the intelligence (algorithms), the complete Schröder EXEDRA system relies on shared and open technologies. Schröder EXEDRA also relies on Microsoft™ Azure for cloud services, provided with the highest levels of trust, transparency, standards conformance and regulatory compliance.

## Breaking the silos

With EXEDRA, Schröder has taken a technology-agnostic approach: we rely on open standards and protocols to design an architecture able to interact seamlessly with third-party software and hardware solutions. Schröder EXEDRA is designed to unlock complete interoperability, as it offers the ability to:

- control devices (luminaires) from other brands
- manage controllers and to integrate sensors from other brands
- connect with third-party devices and platforms

## A plug-and-play solution

As a gateway-less system using the cellular network, an intelligent automated commissioning process recognises, verifies and retrieves luminaire data into the user interface. The self-healing mesh between luminaire controllers enables real-time adaptive lighting to be configured directly via the user interface. OWLET IV luminaire controllers, optimised for Schröder EXEDRA, operate Schröder's luminaires and luminaires from third parties. They use both cellular and mesh radio networks, optimising geographical coverage and redundancy for continuous operation.

## Tailored experience

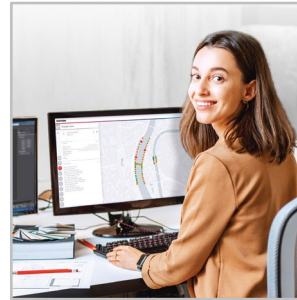

Schröder EXEDRA includes all advanced features needed for smart device management, real-time and scheduled control, dynamic and automated lighting scenarios, maintenance and field operation planning, energy consumption management and third-party connected hardware integration. It is fully configurable and includes tools for user management and multi-tenant policy that enables contractors, utilities or big cities to segregate projects.

## A powerful tool for efficiency, rationalisation and decision making

Data is gold. Schröder EXEDRA brings it with all the clarity managers need to drive decisions. The platform collects massive amounts of data from end devices and, aggregates, analyses and intuitively displays them to help end-users take the right actions.

## Protected on every side



Schröder EXEDRA provides state-of-the-art data security with encryption, hashing, tokenisation, and key management practices that protect data across the whole system and its associated services. The whole platform is ISO 27001 certified. It demonstrates that Schröder EXEDRA meets the requirements for establishing, implementing, maintaining and continually improving security management.

## Mobile App: any time, any place, connect to your street lighting

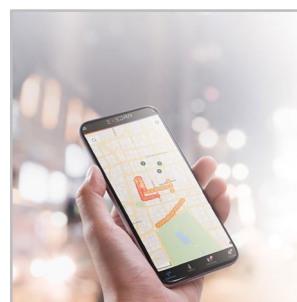

The Schröder EXEDRA mobile application offers the essential functionalities of the desktop platform, to accompany all types of operator on site in their daily effort to maximise the potential of connected lighting. It enables real-time control and settings, and contributes to effective maintenance.



With the PureNight concept, Schröder offers the ultimate solution for restoring the night sky without switching off cities, while maintaining safety and well-being for people and preserving wildlife. The PureNight concept guarantees that your Schröder lighting solution satisfies environmental laws and requirements. Well-designed LED lighting has the potential to improve the environment in all respects.

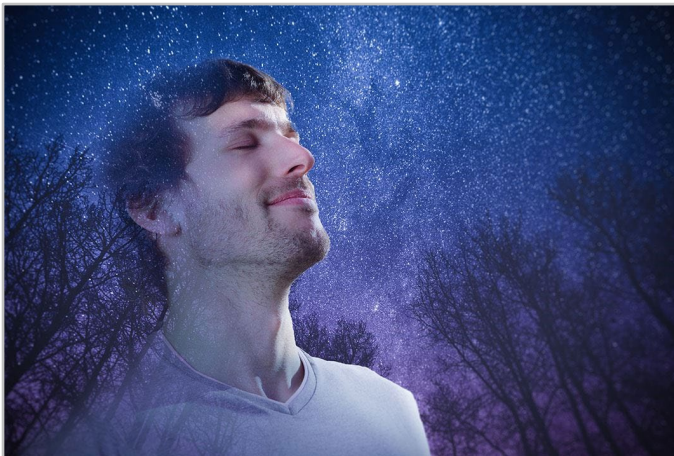

### Direct the light only where it is wanted and needed

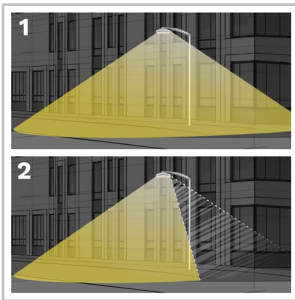

1. Without backlight  
2. With backlight

Schröder is renowned for its expertise in photometry. Our optics direct light only where it is wanted and needed. However, light trespass behind the luminaire might be a key concern when it comes to protecting a sensitive wildlife habitat or avoiding intrusive lighting towards buildings. Our fully integrated backlight solutions easily address this potential risk.

### Offer maximum visual comfort to people

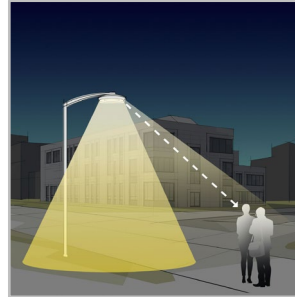

Because of the lower installation height compared to road lighting, visual comfort is an essential aspect of urban lighting. Schröder designs lenses and accessories to minimise any type of glare (distracting, discomforting, disabling glare and blinding glare). Our design offices harness a range of possibilities to find the best solutions for each project and ensure that we provide a gentle light that delivers the best night-time experience.

### Protect wildlife

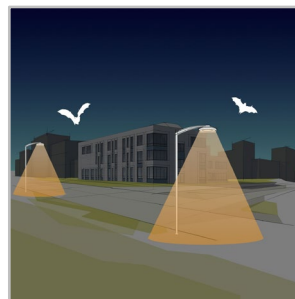

If not well designed, artificial lighting can badly affect wildlife. Blue light and excessive intensity can have a damaging effect on all types of life. Blue light radiation has the ability to suppress the production of melatonin, the hormone that contributes to the regulation of the circadian rhythm. It can also alter the behavioural patterns of animals including bats and moths, as it can change their movements towards or away from light sources. Schröder

favours warm white LEDs with minimal blue light, combined with advanced control systems including sensors. This enables permanent adaptation of the lighting to the real needs of the moment, minimising disturbance to the fauna and flora.

### Choose a Dark Sky certified luminaire



The International Dark-Sky Association (IDA) is the recognised authority on light pollution. It provides leadership, tools and resources to industries and companies willing to reduce light pollution. The IDA's Fixture Seal of Approval programme certifies outdoor lighting fixtures as being Dark Sky Friendly. All products approved by this programme must comply with the following criteria:

- The light sources shall have a maximum correlated colour temperature of 3000K;
- Uplight allowance limited to 0.5% of total output, or 50 lumens, with no more than
  - 10 lumens in the 90-100 degree UL zone;
- The luminaires must have a dimming capability to 10% of full rating;
- The luminaires must be equipped with a fixed mounting option;
- The luminaires must have Safety Certification by an independent laboratory.

This approved Schröder range of luminaires complies with these requirements.

GENERAL INFORMATION		ELECTRICAL INFORMATION	
Recommended installation height	4m to 45m   13' to 148'	Electrical class	Class 1 US, Class I EU, Class II EU
Driver included	Yes	Nominal voltage	120-277V – 50-60Hz 220-240V – 50-60Hz 347-480V – 50-60Hz
CE mark	Yes	Surge protection options (kV)	6 8 10 20
CB mark	Yes	Electromagnetic compatibility (EMC)	EN 55015 / EN 61000-3-2 / EN 61000-3-3 / EN 61547 EN 61547 / EN 61000-4-2, -3, -4, -5, -6, -8, -11
ENEC certified	Yes	Control protocol(s)	1-10V, DALI
ENEC+ certified	Yes	Control options	Custom dimming profile, Remote management
UL certified	Yes	Socket	Zhaga (optional) NEMA 7-pin (optional)
ROHS compliant	Yes	Associated control system(s)	Schröder EXEDRA
Dark Sky friendly lighting (IDA certification)	Yes	<b>OPTICAL INFORMATION</b>	
French law of December 27th 2018 - Compliant with application type(s)	a, b, c, d, e, f, g	LED colour temperature	2200K (Warm White WW 722) 2700K (Warm White WW 727) 3000K (Warm White WW 730) 3000K (Warm White WW 830) 4000K (Neutral White NW 740)
RCM mark	Yes	Colour rendering index (CRI)	>70 (Warm White WW 722) >70 (Warm White WW 727) >70 (Warm White WW 730) >80 (Warm White WW 830) >70 (Neutral White NW 740)
Testing standard	EN 60598-1 LM 79-08 (all measurements in ISO17025 accredited laboratory) EN 60598-2-3:2003/A1:2011	ULOR	0%
<b>HOUSING AND FINISH</b>		ULR	0%
Housing	Aluminium	<ul style="list-style-type: none"> <li>· Meets IDA Dark Sky requirements when fitted with LEDs of 3000K or less.</li> <li>· ULOR may be different according to the configuration. Please consult us.</li> <li>· ULR may be different according to the configuration. Please consult us.</li> </ul>	
Optic	PMMA	<b>LIFETIME OF THE LEDS @ TQ 25°C</b>	
Protector	Tempered glass	All configurations	100,000h - L95
Housing finish	Polyester powder coating	<ul style="list-style-type: none"> <li>· Lifetime may be different according to the size/configurations. Please consult us.</li> </ul>	
Standard colour(s)	RAL 7040 window grey		
Tightness level	IP 66		
Impact resistance	IK 09		
Vibration test	Compliant with ANSI 1.5G and 3G and modified IEC 68-2-6 (0.5G)		
Access for maintenance	Tool-less access to gear compartment		
<ul style="list-style-type: none"> <li>· Any other RAL or AKZO colour upon request</li> <li>· Optional high anti-corrosive aluminium (compliant with EN AC-44300)</li> </ul>			
<b>OPERATING CONDITIONS</b>			
Operating temperature range (Ta)	-40°C up to +55°C / -40°F up to 131°F with wind effect		
<ul style="list-style-type: none"> <li>· Depending on the luminaire configuration. For more details, please contact us.</li> </ul>			

## DIMENSIONS AND MOUNTING

AxBxC (mm   inch)	AVENTO GEN2 S : 350x127x310   13.8x5.0x12.2 AVENTO 1 : 485x114x310   19.1x4.5x12.2 AVENTO 2 : 655x159x359   25.8x6.3x14.1 AVENTO 3 : 655x158x578   25.8x6.2x22.8
Weight (kg   lbs)	AVENTO GEN2 S : 5.8   12.8 AVENTO 1 : 8.1   17.8 AVENTO 2 : 11.7   25.7 AVENTO 3 : 18.6   40.9
Aerodynamic resistance (CxS)	AVENTO GEN2 S : 0.02 AVENTO 1 : 0.02 AVENTO 2 : 0.03 AVENTO 3 : 0.05
Mounting possibilities	Side-entry slip-over – Ø42mm Side-entry slip-over – Ø48mm Side-entry slip-over – Ø60mm

· For more information about mounting possibilities, please consult the installation sheet.

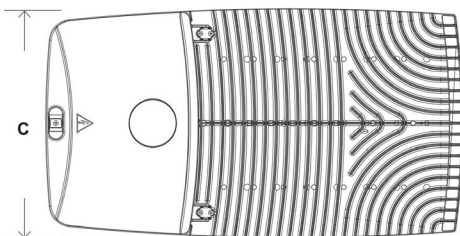
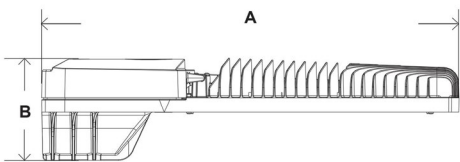



AVENTO | Side-entry mounting from Ø42 to Ø60mm spigots

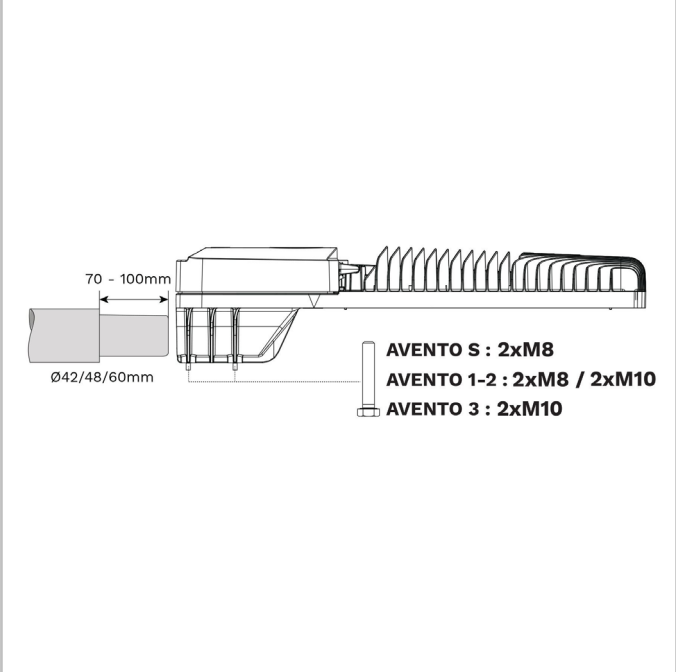

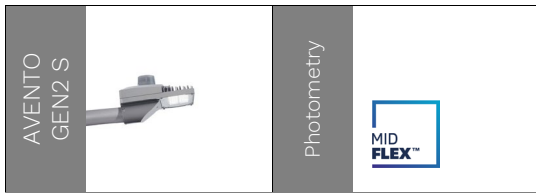

	Luminaire output flux (lm)				Power consumption (W)		Luminaire efficacy (lm/W)
	Warm White WW 730		Neutral White NW 740		Min	Max	
Number of LEDs	Min	Max	Min	Max	Min	Max	Up to
48	2400	4700	2500	5000	18	38	151
96	4800	9500	5200	10100	35	74	160

Tolerance on LED flux is ± 7% and on total luminaire power ± 5 %



	Luminaire output flux (lm)								Power consumption (W)		Luminaire efficacy (lm/W)
	Warm White WW 722		Warm White WW 727		Warm White WW 730		Neutral White NW 740		Min	Max	
Number of LEDs	Min	Max	Min	Max	Min	Max	Min	Max	Min	Max	Up to
72	4000	18600	4500	21000	4700	21900	5000	23500	30	152	176
96	4900	24200	5500	27300	5800	28400	6200	30600	40	206	170
108	5500	20000	6200	22600	6500	23500	7000	25300	46	154	175
144	7300	26700	8300	30200	8600	31400	9300	33800	56	201	183

Tolerance on LED flux is ± 7% and on total luminaire power ± 5 %

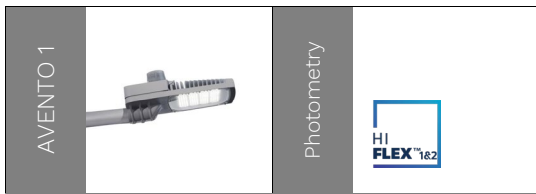

Number of LEDs	Luminaire output flux (lm)								Power consumption (W)		Luminaire efficacy (lm/W)
	Warm White WW 722		Warm White WW 727		Warm White WW 730		Neutral White NW 740				
	Min	Max	Min	Max	Min	Max	Min	Max	Min	Max	Up to
72	4000	18600	4500	21000	4700	21900	5000	23500	30	152	176
96	4900	24200	5500	27300	5800	28400	6200	30600	40	206	170
108	5500	20000	6200	22600	6500	23500	7000	25300	46	154	175
144	7300	26700	8300	30200	8600	31400	9300	33800	56	201	183

Tolerance on LED flux is ± 7% and on total luminaire power ± 5 %



Number of LEDs	Luminaire output flux (lm)						Power consumption (W)		Luminaire efficacy (lm/W)
	Warm White WW 727		Warm White WW 730		Neutral White NW 740				
	Min	Max	Min	Max	Min	Max	Min	Max	Up to
40	3000	10800	3300	11800	3500	12500	25	89	164
60	4600	16000	5000	17500	5300	18600	37	129	167
80	6100	21600	6700	23700	7100	25100	48	172	171

Tolerance on LED flux is ± 7% and on total luminaire power ± 5 %



Number of LEDs	Luminaire output flux (lm)								Power consumption (W)		Luminaire efficacy (lm/W)
	Warm White WW 722		Warm White WW 727		Warm White WW 730		Neutral White NW 740				
	Min	Max	Min	Max	Min	Max	Min	Max	Min	Max	Up to
96	4900	24200	5500	27300	5800	28400	6200	30600	40	206	170
144	7300	26700	8300	30200	8600	31400	9300	33800	56	201	183
192	-	-	-	-	18100	18800	19400	20100	147	150	137

Tolerance on LED flux is ± 7% and on total luminaire power ± 5 %

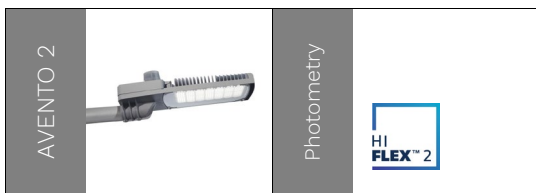

Number of LEDs	Luminaire output flux (lm)								Power consumption (W)		Luminaire efficacy (lm/W)
	Warm White WW 722		Warm White WW 727		Warm White WW 730		Neutral White NW 740				
	Min	Max	Min	Max	Min	Max	Min	Max	Min	Max	Up to
216	11100	39500	12600	44600	13100	46400	14100	50000	82	296	186

Tolerance on LED flux is ± 7% and on total luminaire power ± 5 %



Number of LEDs	Luminaire output flux (lm)								Power consumption (W)		Luminaire efficacy (lm/W)
	Warm White WW 722		Warm White WW 727		Warm White WW 730		Neutral White NW 740		Min	Max	Up to
	Min	Max	Min	Max	Min	Max	Min	Max			
144	8400	28800	9500	32500	9900	33800	10600	36400	56	228	196
216	11100	39500	12600	44600	13100	46400	14100	50000	82	296	186

Tolerance on LED flux is ± 7% and on total luminaire power ± 5 %



Number of LEDs	Luminaire output flux (lm)						Power consumption (W)		Luminaire efficacy (lm/W)
	Warm White WW 727		Warm White WW 730		Neutral White NW 740		Min	Max	Up to
	Min	Max	Min	Max	Min	Max			
80	6100	21600	6700	23700	7100	25100	46	172	181
100	7700	27000	8400	29600	8900	31400	58	220	180
120	9200	32100	10100	35100	10700	37200	74	258	169

Tolerance on LED flux is ± 7% and on total luminaire power ± 5 %



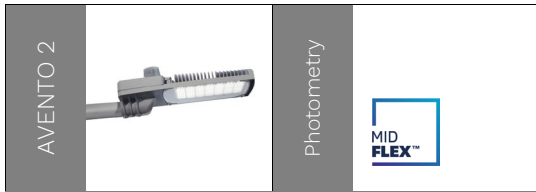

Number of LEDs	Luminaire output flux (lm)				Power consumption (W)		Luminaire efficacy (lm/W)
	Warm White WW 730		Neutral White NW 740		Min	Max	
	Min	Max	Min	Max			Up to
240	22900	23500	24500	25100	171	176	147
288	27500	28200	29400	30200	212	222	143
336	32100	32900	34400	35200	248	250	142

Tolerance on LED flux is ± 7% and on total luminaire power ± 5 %



Number of LEDs	Luminaire output flux (lm)						Power consumption (W)		Luminaire efficacy (lm/W)
	Warm White WW 730		Warm White WW 830		Neutral White NW 740		Min	Max	
	Min	Max	Min	Max	Min	Max			Up to
144	24600	38000	21800	33700	26700	41200	218	308	144
192	32800	50700	29100	44900	35600	54900	284	402	147

Tolerance on LED flux is ± 7% and on total luminaire power ± 5 %

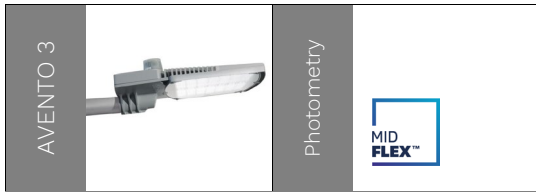

	Luminaire output flux (lm)				Power consumption (W)		Luminaire efficacy (lm/W)
	Warm White WW 730		Neutral White NW 740		Min	Max	
Number of LEDs	Min	Max	Min	Max	Min	Max	Up to
384	27100	37400	29000	40000	202	290	150
480	33900	46800	36300	50000	246	356	154
576	40700	56200	43600	60100	292	422	155
672	47900	65500	51200	70100	342	490	156

Tolerance on LED flux is ± 7% and on total luminaire power ± 5 %

